

**Intelligent Active Equalizer
(HT-24S15EB)
User Manual V1.4**

Heltec Energy

Product Warranty Terms

Product name: Intelligent Active Equalizer

Warranty period: One year

First of all, thank you for purchasing the Intelligent Active Equalizer from Chengdu Heltec Energy Technology Co., Ltd.

Our company provides a warranty on hardware products and accessories sold by us, and the warranty period is one year. If equalizer fails to work because of quality reason during the warranty period, our company have the right to repair or replace the whole product upon receipt of notification of product failure and after inspection and verification. The replacements are new or nearly new.

1. Heltec Energy promise that the products are well tested.
2. Heltec Energy does not guarantee the product could be used continually during the process of repairing. But our company guarantee repair the defective product within a reasonable period.
3. The product warranty period starts from the date of shipment of the product or the date of installation by Heltec Energy. If the installation of the product is not started within 30 days after the date of shipment because of the customer's schedule or delay, the product warranty period will be calculated from the 31st day after the date of shipment.
4. Heltec Energy does not provide free product warranty for product failure and damage caused by any of the following conditions:
 - (a) Misuse and improper maintenance;
 - (b) Any software, accessories, parts or other items not provided by Heltec Energy;
 - (c) Unauthorized disassembly, modification and misuse;
 - (d) Use the product in violation of specifications;
 - (e) Improper transportation, carrying and deposit;

(f) Failed or damaged by other reason expect quality reason(such as earthquake, war, traffic accident and so on).

The above warranty is the only one that is expressly stated to the extent permitted by law, meanwhile there is no other warranty whether written or oral. Any implied warranty terms and conditions of business are expressly disclaimed.

Copyright statement

All products sold by Heltec Energy, including software and files sold with hardware products, the copyright belongs to Chengdu Heltec Energy Technology Co., Ltd. and Heltec Energy retains all copyrights on the products and files. The customer's purchase of the product does not imply any license of the user in terms of copyright. Any reproduction and sale without the written permission of Heltec Energy is prohibited.

Content

1. Overview	1
2. Main Technical Indicators	1
3. Product Pictures	2
3.1 Product Appearance	2
3.2 Accessories	3
3.3 Connector Picture	4
3.3.1 Cefinition	4
3.3.2 Connector PIN Definition	4
3.3.3 External TTL Communication Interface	5
3.3.4 Password Reset Switch	5
4. Indicator Light Definition	6
5. Product Dimension (mm)	7
6. Equalization Introduction	8
6.1 The Theory of Equalization	8
6.2 Single Transfer Capacity	8
6.3 The Strategy of Capacity Equalization	8
7. Installation and Notice	9
7.1 Unpacking Inspections and Precautions	9
7.2 Single Equalizer Installation Instructions	9
7.2.1 24S Wiring Method	10
7.2.2 Less than 24S Wiring Method	10
7.2.3 Wiring Diagram: When the Battery Pack Voltage is Lower Than 12V	10
7.3 Multi-Equalizer Installation Instructions	11
8. APP Download and Use	11
8.1 APP Download	11
8.2 APP Use	12
8.2.1 Pre-Use Check	12
8.2.2 Operation	12
9. General Fault Analysis and Buzzer Instructions	16
9.1 General Fault Analysis	16
9.2 Buzzer Alarm Instructions	17
9.3 Buzzer Instructions	18
10. Safety Protection, Transportation and Storage	18
10.1 Safety Protection Measures	18
10.2 Transportation	18
10.3 Storage	19

1. Overview

Intelligent Active Equalizer (HT-24S15EB) is a tailor-made equalization management system for high-capacity series-connected battery packs.

This equalizer uses Super-capacitors as a medium to achieve active energy transfer equalization.

This equalizer is suitable for 2~24 series battery packs with voltage acquisition and equalization functions. The equalizer works with a continuous 15A equalization current to achieve energy transfer, and the equalization current does not depend on the voltage difference of the series-connected cells in the battery pack. The voltage acquisition range is 1.5V~4.5V, and the precision is 1mV. Which is applicable to the mainstream lithium ternary, lithium iron phosphate and lithium titan-ate batteries in the market.

This equalizer is equipped with Bluetooth and phone APP software. You can connect the equalizer via Bluetooth to check the voltage of single battery, check the equalization status, modify the setting parameters and other operations.

It can be used in the battery PACK of small sightseeing cars, mobility scooters, shared cars, high-power energy storage, base station backup power, solar power stations, etc., and can also be used for battery equalization repair and restoration.

2. Main Technical Indicators

SKU	HT-24S15EB
Applicable Number of Strings	2-24S
Cascade Connection	Support
Size (mm)	L313*W193*H43
Net Weight (g)	2530
Reserved Battery Protection	Support disordered power-up detection/protection
External Power Supply	DC 12-120V
Applicable Battery Type	NCM/ LFP/ LTO

Voltage Acquisition Range	1.5V~4.5V
Undervoltage Protection - Hibernation Voltage	Customizable settings on APP: 1.5-4.2V.
Equalization Method	Single-channel transfer separately, point-to-point energy transfer.
Voltage Equalization Precision	Customizable settings on APP: 1mV (typical value)
Whether External Power Supply is Required	Battery power available (precision: 3mV) , external power (precision: 1mV)
Power-down Detection Function	Support
Wrong Wiring Protection Function	Support
Malfunction Alarm Function	Support
Buzzer	Customizable settings on APP
Power Consumption	When the equalization system working $\approx 1W$, the equalization system closed $\approx 0.5W$.
Working Environment Temperature	-20°C~ +45°C

3. Product Pictures

3.1 Product Appearance



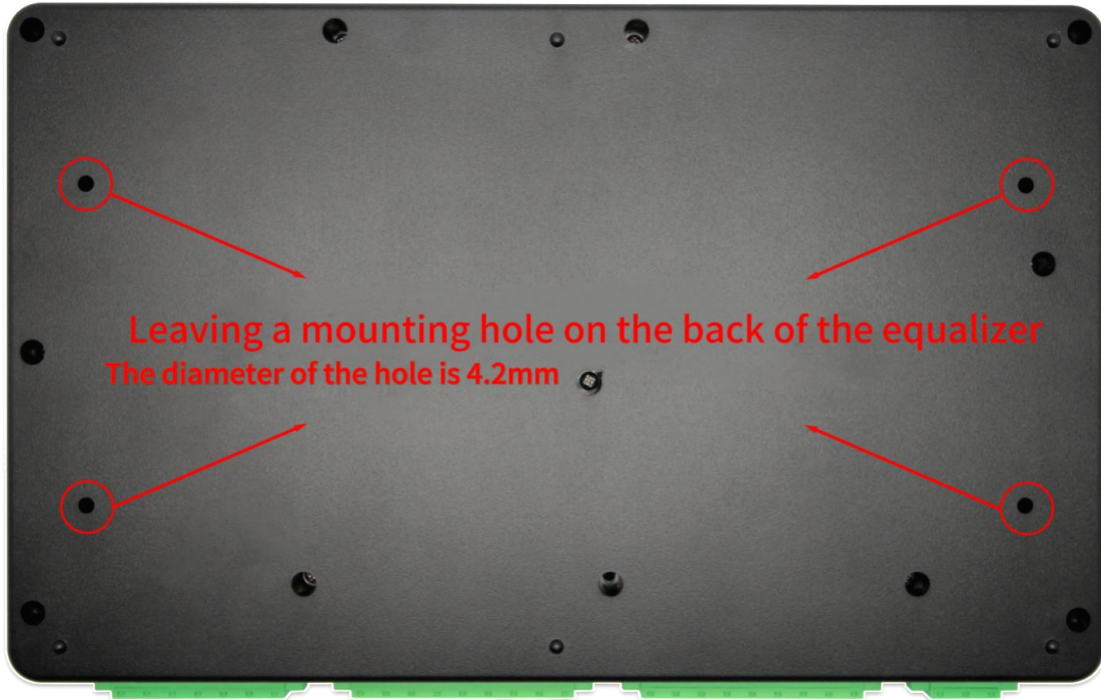

3.2 Accessories

Note: Accessories are shipped in a separate box, please don't forget.



Accessories list: 24*1 meter clip lines + one set 7.62 connector + DC

3.3 Connector

3.3.1 Connector Picture

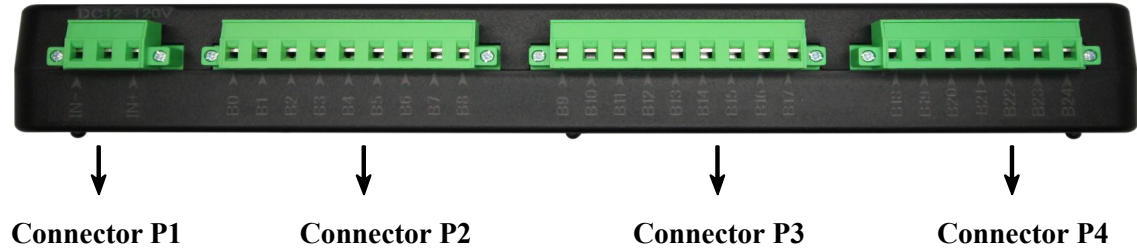

3.3.2 Connector PIN Definition

Connector	PIN No.	Name	Definition
P1	1	IN-	Input Negative Pole (DC 12-120V)
	2	NC	Empty
	3	IN+	Input Positive Pole (DC 12-120V)
P2	1	B0	1 st string negative pole
	2	B1	1 st string positive pole
	3	B2	2 nd string positive pole
	4	B3	3 rd string positive pole
	5	B4	4 th string positive pole
	6	B5	5 th string positive pole
	7	B6	6 th string positive pole
	8	B7	7 th string positive pole
P3	9	B8	8 th string positive pole
	1	B9	9 th string positive pole
	2	B10	10 th string positive pole
	3	B11	11 st string positive pole
	4	B12	12 rd string positive pole
	5	B13	13 th string positive pole
	6	B14	14 th string positive pole

	7	B15	15 th string positive pole
	8	B16	16 th string positive pole
	9	B17	17 th string positive pole
P4	1	B18	18 th string positive pole
	2	B19	19 th string positive pole
	3	B20	20 th string positive pole
	4	B21	21 st string positive pole
	5	B22	22 nd string positive pole
	6	B23	23 rd string positive pole
	7	B24	24 th string positive pole

3.3.3 External TTL Communication Interface



3.3.4 Password Reset Switch



4. Indicator Light Definition



Green - Power supply status indicator light

Always on: power supply is good

Blue - Bluetooth status indicator light

Always on: connected successfully

Flash: disconnect

Yellow - Work status indicator light

Always on: equalization is finished

Flash: equalizer at work

Red - Malfunction status indicator light

Always on: The number of battery cells does not match the setting

Flash: The resistance of equalizer line is excessive

5. Product Dimension (mm)

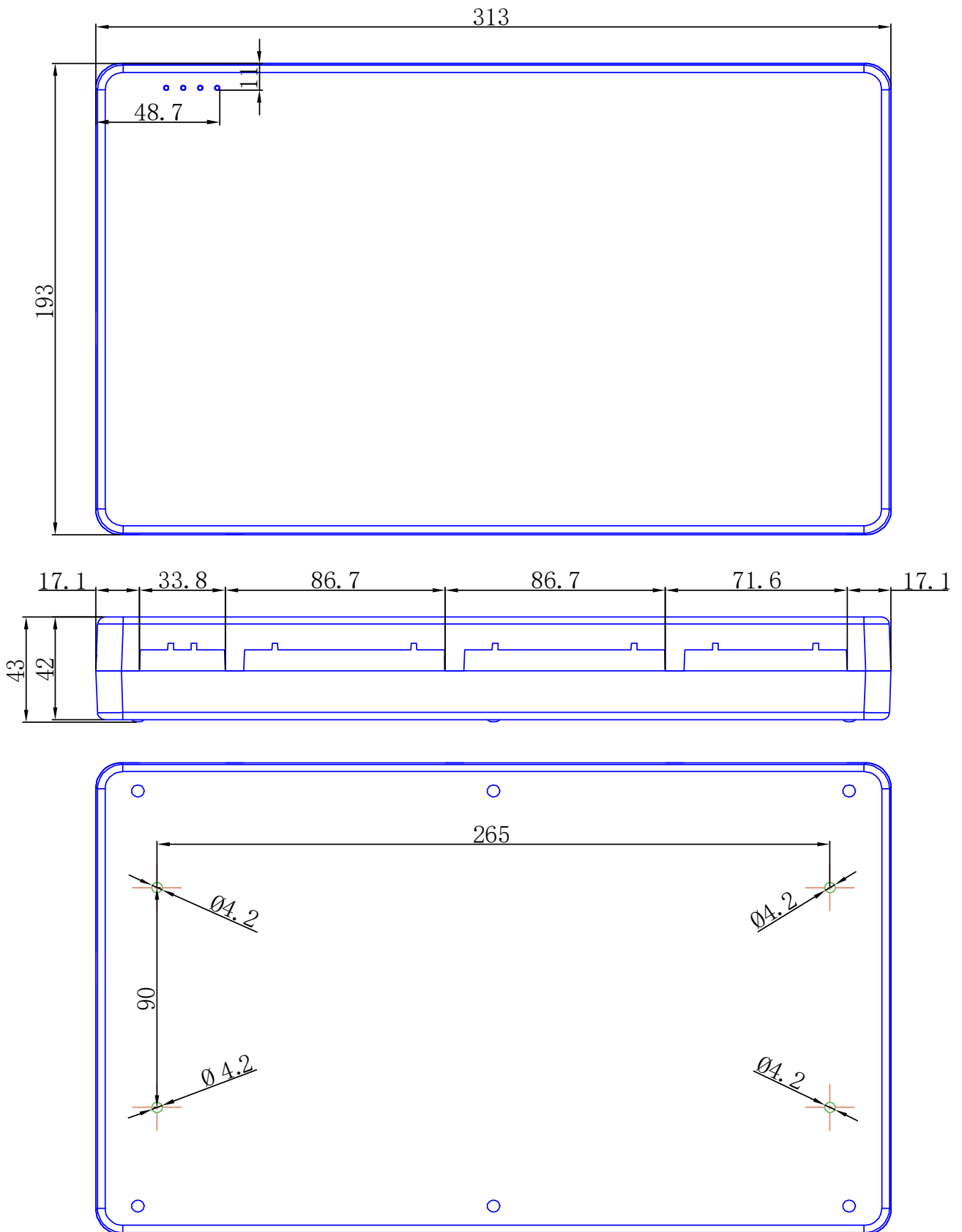

6. Equalization Introduction

6.1 The Theory of Equalization

The equalization process of this active equalizer consists of the following three steps, which are cycled sequentially until the maximum differential pressure is within the set range:

1. Detecting the largest and smallest monomers;
2. Maximum monomer charging to the super-capacitor of the equalizer, charging current is the set current, maximum 15A;
3. The super-capacitor of the equalizer discharge to the smallest monomer, discharging current is the set current, maximum 15A;
4. Repeat steps 1 to 3 until the differential pressure is within the set range.

6.2 Single Transfer Capacity

Equalizer single transfer capacity formula:

equalizer current / 3600 * time duration (2-5s).

Eg. if the equalization current is 15A, then the single transfer capacity is 0.008Ah ~ 0.0208Ah.

If the capacity of the equalized battery is relatively small or the capacity difference is relatively small, there will be excessive capacity transfer, such as the capacity difference of the largest single monomer compared to the smallest single monomer is 0.1Ah, and the equalization current is set to 15A now, there will be excessive capacity transfer, the original smallest single monomer become the largest single monomer after the end of equalization cycling, and the largest single monomer become the smallest single monomer. The simplest solution is to reduce the equalization current.

6.3 The Strategy of Capacity Equalization

In order to deal with the situation of excessive energy transfer when the capacity

difference is relatively small, the 15A equalizer has designed an equalization strategy to deal with this situation. When the equalization cycle is finished, the original smallest cell becomes the largest cell and the largest cell becomes the smallest cell, and the equalizer waits for 3 minutes to let the battery voltage have a recovery time. If the largest cell becomes the smallest cell and the smallest cell becomes the largest cell after the 3-minute period, it means that the equalization has been over-equalized, and at this time the equalizer will reduce the equalization current by half, for example, the original equalization current is 15A, but now it is reduced to 7.5A. The equalizer automatically reduces the equalizing current by half. If there is still an over-equalization situation, continue to reduce the equalization current until the pressure difference is within the set range.

7. Installation and Notice

7.1 Unpacking Inspections and Precautions

- Packing boxes, equalizers, etc. should be handled carefully and not inverted.
- Before opening the box, pay attention to whether the packaging is complete, such as whether there are crashes marks, damage, etc.

7.2 Single Equalizer Installation Instructions

- Connect IN- to the total negative pole of the battery pack (B-/B0); Connect IN+ to the last string. As 7.2.1 shown.
- When the voltage of the battery pack is lower than 12V, equalizer needs DC power supply (12V-120V).
- Connect IN- to the negative pole of power supply, and connect IN+ to the positive pole of power supply. As 7.2.3 shown.
- When the battery pack with less than 24 strings of cells in series, the free pins are left hanging. As 7.2.2 shown.

7.2.1 24S Wiring Method

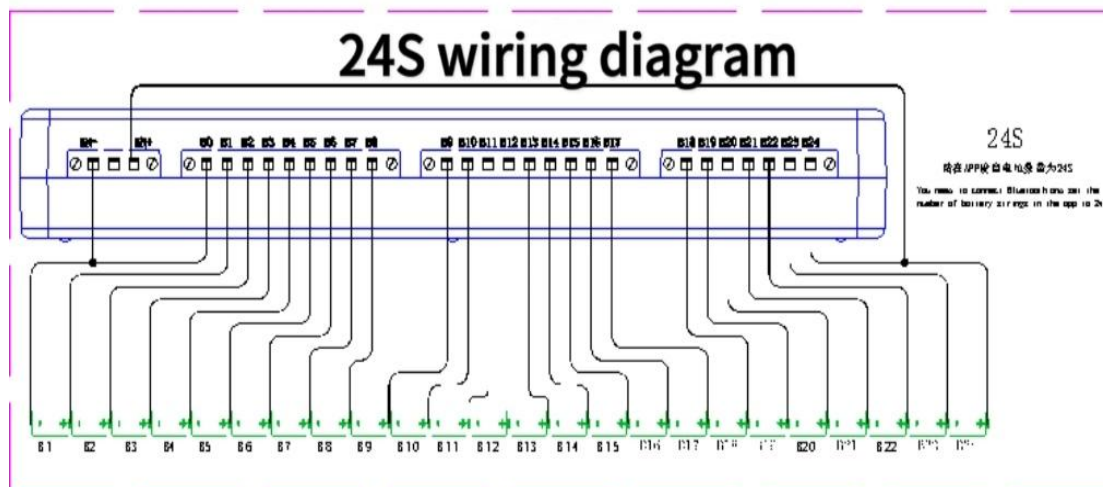

7.2.2 Less than 24S Wiring Method

For the battery pack with less than 24 strings of cells in series, the wiring diagram as below (take 17S as an example):

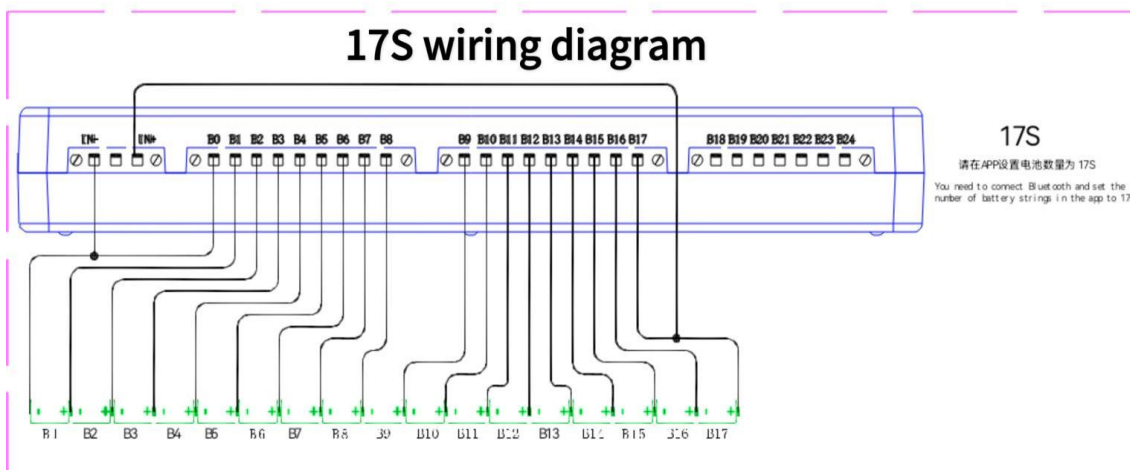

7.2.3 Wiring Diagram: When the Battery Pack Voltage is Lower Than 12V

When the battery pack voltage is lower than 12V, external DC 12V-120V power supply is required, please use our matching power adapter. The wiring diagram as below(take 3S as an example):

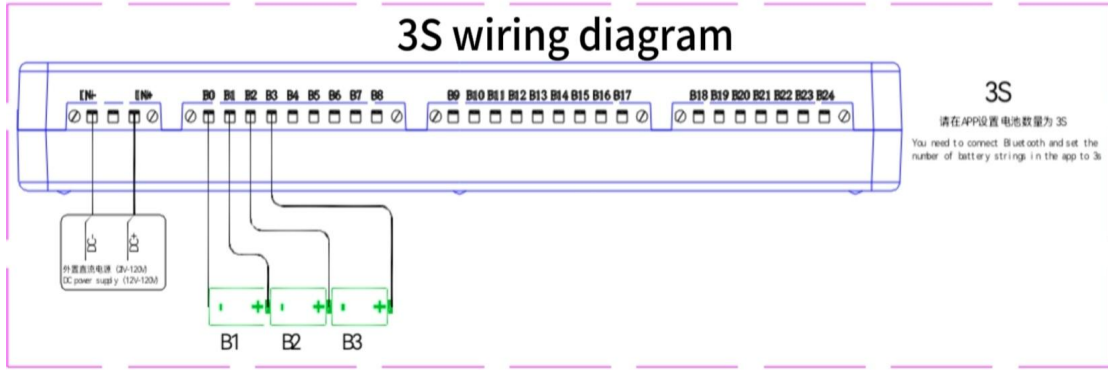

7.3 Multi-Equalizer Installation Instructions

HT-24S15EB supports cascade use, the wiring diagram of cascade using as below (take 40S as an example):

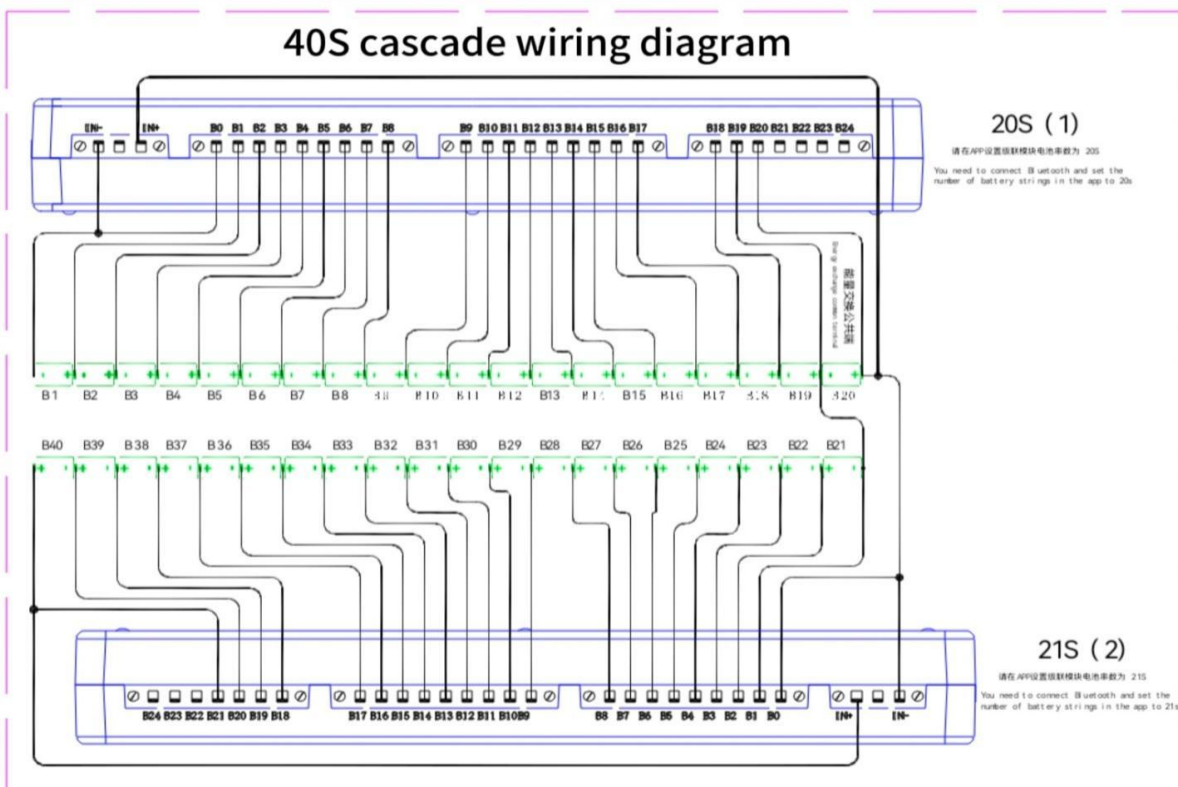

8. APP Download and Use

8.1 APP Download

The APP has two version: Android and IOS, both support Chinese and English. The IOS users can search Enerkey on the APP store. The Android users can download it on BaiduNetdisk or download it on the official website.

BaiduNetdisk link: <https://pan.baidu.com/e/1r-HFiB8KfPVy5SpIVK1iTA>

8.2 APP Use

8.2.1 Pre-Use Check

After downloading the APP, be sure to turn on the location and allow the APP to use the location information, if the location not be allowed, the APP can not receive the information of equalizer.

Before opening the power supply, please check the connection of equalizer line is right and the power provided within requirement; check whether the equalizer has been placed securely, confirm that the circuit board has no short-circuit, etc, confirm that there is no error before you can turn on the equalizer power.

8.2.2 Operation

Firstly, connected equalizer (Be sure to turn on location and allow the app to receive location information), as shown in the picture below; After connecting the device and entering the APP, the system will automatically start scanning the device.

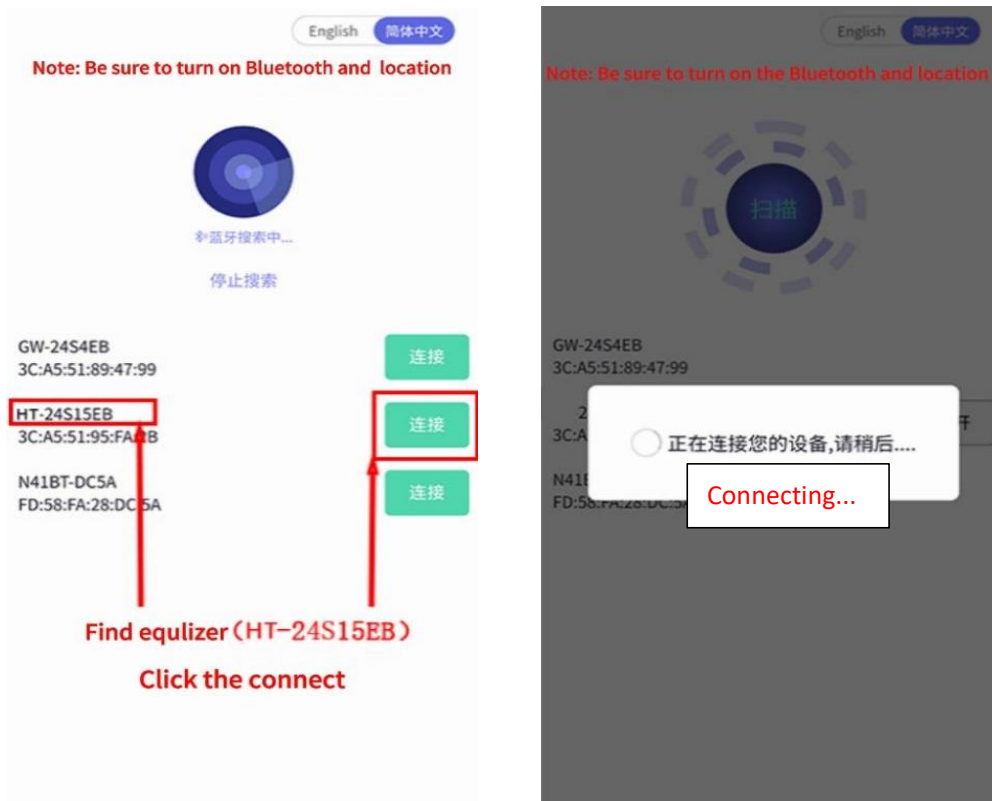

Secondly, after successful connection, start the equalization switch. As shown in the picture below.

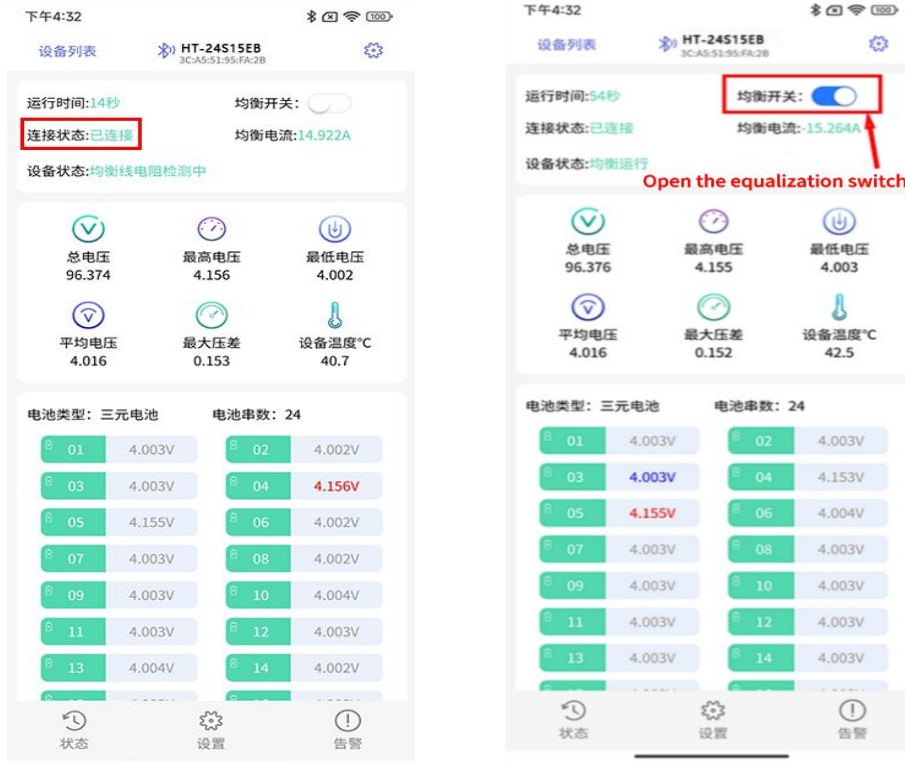

Thirdly, according to the battery type and strings, change the parameters (A password is required to access the settings for the first time) As shown in the picture below.

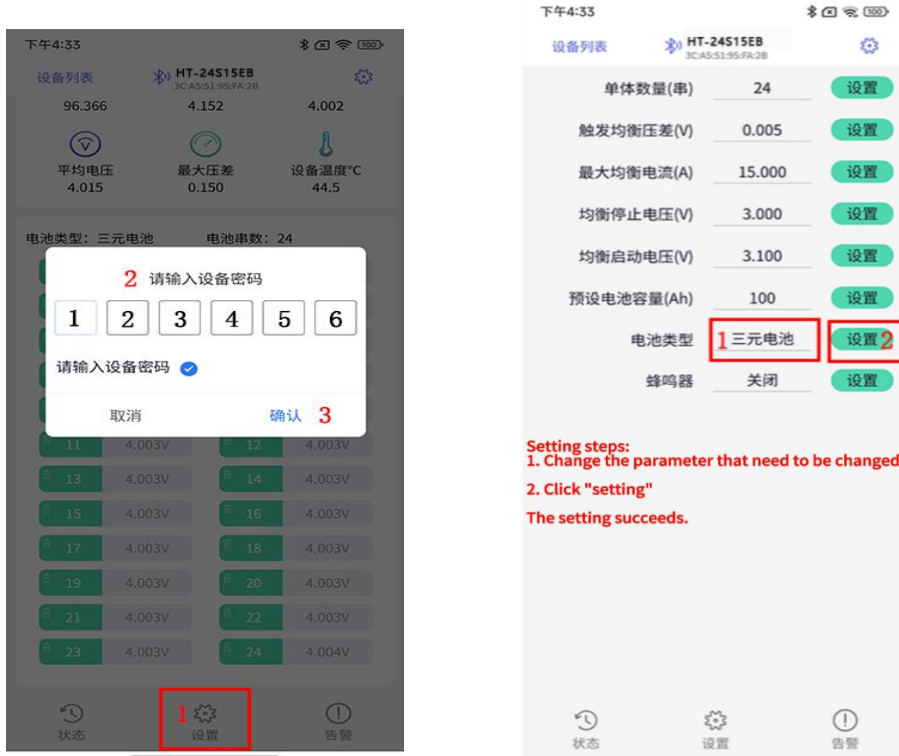

Setting steps:
 1. Change the parameter that need to be changed.
 2. Click "setting"
 The setting succeeds.



Fourth step, once the required parameters have been set, you can monitor the parameters of each individual cell from the "Status" or "Warning" page.

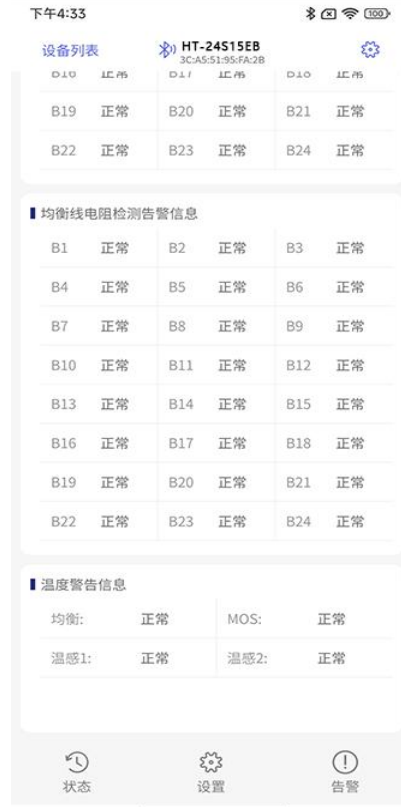
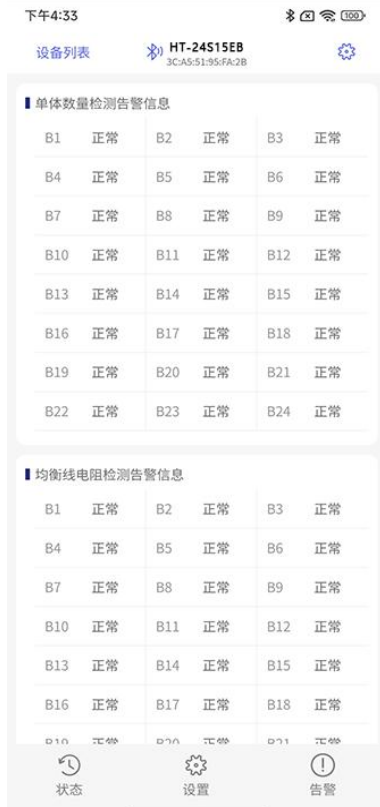

Specific instruction: The Equalizer stops functioning when the Equalizer Switch is turned off or when the power is removed. If you need to replace the connecting device, steps as shown in the picture below.



Note: Be sure to turn on the Bluetooth and location

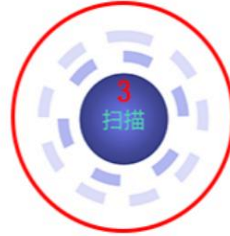

GW-24S4EB
3C:A5:51:89:47:99

N41BT-DC5A
FD:58:FA:28:DC:5A

HT-24S15EB
3C:A5:51:95:FA:2B



Steps to replace the equipment:

1. Click "equipment list"

2. Disconnect the connected equipment

3. After clicking "scan", repeat the first step

Finally, the step of modify the password shown in the picture below:



To modify the password:

1. Click ⚙️ (set icon)

2. Click "modify password"

3. Enter the new password

4. Click "confirm"

The original password: 123456



9. General Fault Analysis and Buzzer Instructions

9.1 General Fault Analysis

NO.	Failure Situation	Probable Reason	Solutions
1	Power indicator does not light up	Equalizer power supply is not regular	①Check the equalizer power supply pins are connected correctly or not; ②Check the battery pack voltage is lower than 12V or not. If the voltage is lower than 12V, then use the matching power adapter to supply power to the equalizer.
2	Can not find the equalizer on APP	APP has no relevant authorization	Check the Bluetooth turn on; and turn on location and allow the app to use location information.
3	Equalizer does not turn on	The working conditions are wrong	Check whether the voltage of the first string batteries is higher than 2.4V, if it does not meet the conditions, please charge the batteries to more than 2.4V, and then the equalizer will be turned on automatically.
4	APP prompts that the set number of unit does not match the set value	Incorrect number of unit settings or wrong equalizer cable connection	Check the number of unit and the number of connected batteries are same or not.
5	APP prompts that the resistance of	Excessive wire resistance from battery to connector	Check the wires from the battery unit to the connector for poor contact, if there is no poor contact, replace the

	equalization line is excessive		wires.
6	Inaccurate voltage acquisition	Wiring error or parameter setting error	Check the connections one by one to exclude connection errors. adjust voltage acquisition reference until the acquisition is accurate.
7	Cannot be used in cascade	No energy exchange common terminal	Contact customer service or after-sales personnel for wiring diagrams of your required cascade.

Special Note: The above are the possible causes and solutions to general common failures, if you still have not troubleshooting, please contact our after-sales.

9.2 Buzzer Alarm Instructions

No.	Situation	Probable Reason	Solution
1	Buzzer sounds twice every 1 second (Red fault indicator lights up when buzzer sounds)	The hardware data of equalizer storage failure	Contact Us
2	Buzzer sounds 3 times every 0.5 second (Red fault indicator lights on when buzzer sounds)	The communication of Bluetooth is wrong	Contact Us
3	Buzzer sounds 4 times every 0.5 second (Red fault indicator lights up only at intervals)	The hardware of equalizer fails. Super-capacity over-voltage.	Contact Us

Special Note: equalizer hardware problems are seldom, mostly hardware damage caused by operational errors, try reconnecting the equalizer by repeating the connection process several times.

9.3 Buzzer Instructions

No.	Situation	Note
1	When the equalizer is powered on, the buzzer sounds three times. (At this time the green indicator light is always on)	
2	After turning on the equalization work, the buzzer sounds once. (At this time the yellow indicator light flashes)	
3	After the equalization is completed, there is a 3-minute delay in sounding. (At this time the yellow indicator light is always on)	The buzzer function needs to be turned on in the settings.

10. Safety Protection, Transportation and Storage

10.1 Safety Protection Measures

- There is no high voltage in the equalizer and does not cause electric shock damage to the body.
- There are no user-serviceable parts inside the equalizer. All repairs should be performed by qualified service personnel. If the factory-set operating voltage is changed, the safety certificate of compliance no longer applies.
- Before touching the sampling line of the equalizer, the person who performs the operation must discharge the static electricity himself/herself and take anti-static measures.

10.2 Transportation

After packing the products are not subject to the direct influence of rain, snow, violent collision and bumps, they can be transported by the usual tools of transportation. It is not allowed to be put together with acid, alkali and other corrosive materials during transportation.

10.3 Storage

Packaged products should be placed in a permanent warehouse storage, warehouse temperature is 0 °C ~ 35 °C, relative humidity is not bigger than 80%, there is no acid, alkali and corrosive gases in the warehouse, no strong institutions vibration and crash, no strong magnetic field of action.